

**Quality • Beauty • Craftsmanship • Style**



**Castle Moulding<sup>®</sup>**  
**Hardwood**



TEL 818.988.9663 FAX 818.988.4955  
TOLL FREE 800.848.5556

**Castle Moulding • 14959 Delano St. Van Nuys, CA. 91411**

## BASE AVAILABLE IN MANY SPECIES

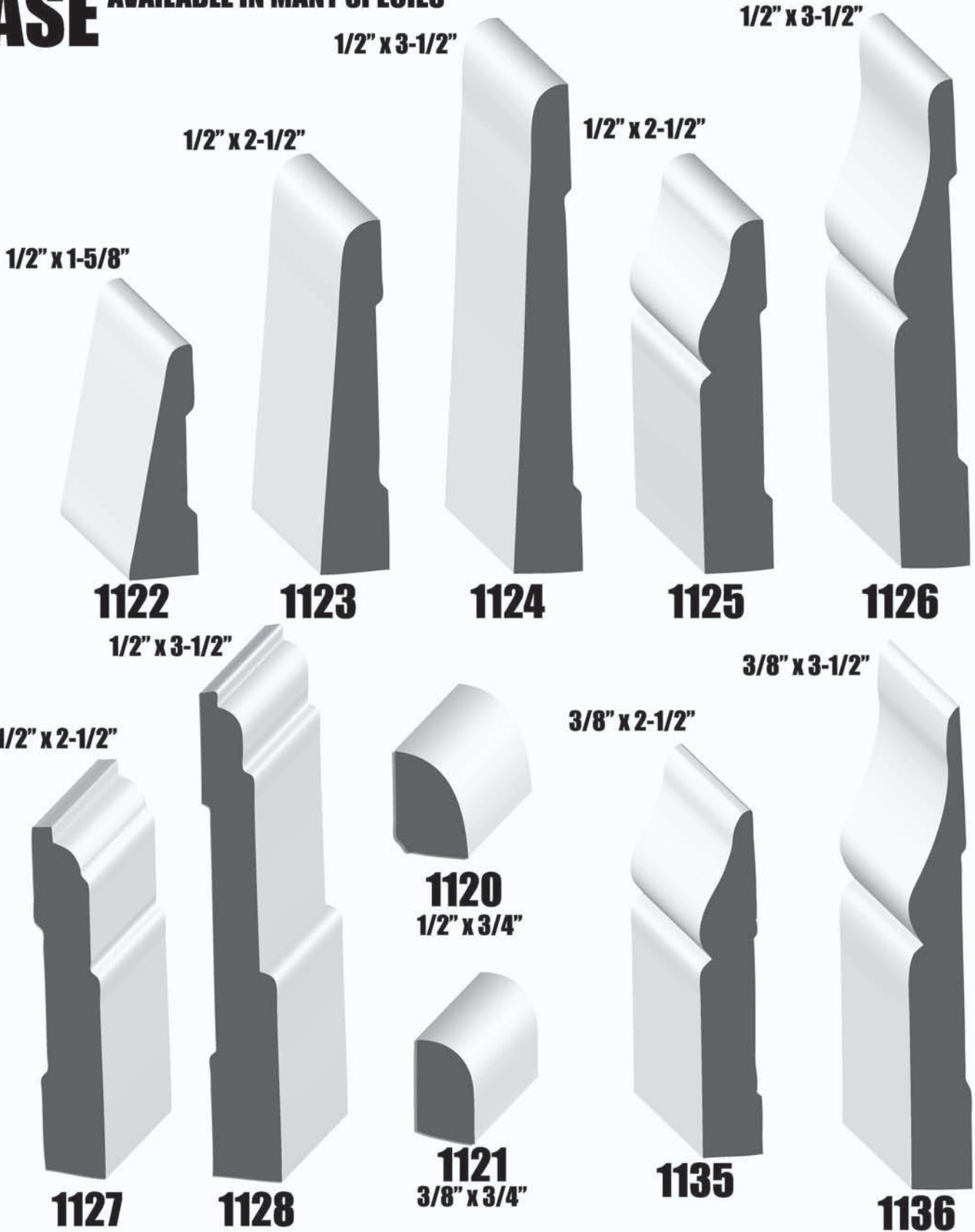

ALL RIGHTS RESERVED. MATERIAL SPECIFICATIONS MAY CHANGE WITHOUT NOTICE.

## BASE AVAILABLE IN MANY SPECIES



**1129** 25/32" X 4"

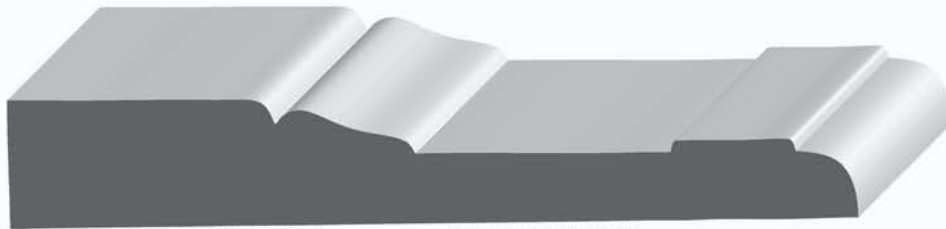

**1130** 11/16" X 4-1/2"



**1131** 11/16" X 4"



**1132** 1/2" X 4-1/2"

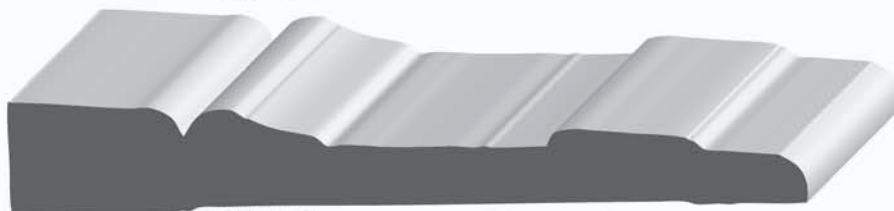

**1140** 5/8" X 4-1/4"



**1141**

**5/8" X 5-1/2"**



**1142**

**25/32" X 5-1/2"**

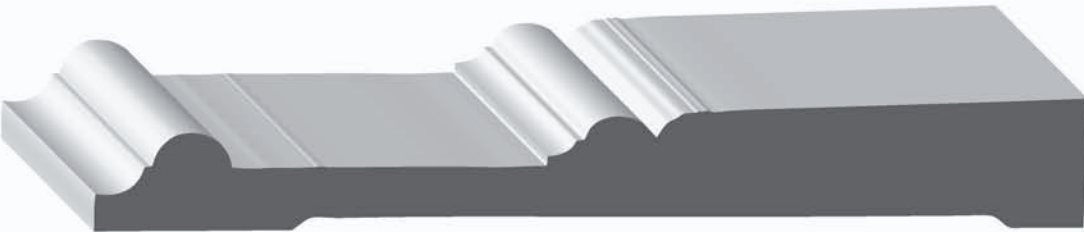

**1143**

**11/16" X 5-1/4"**

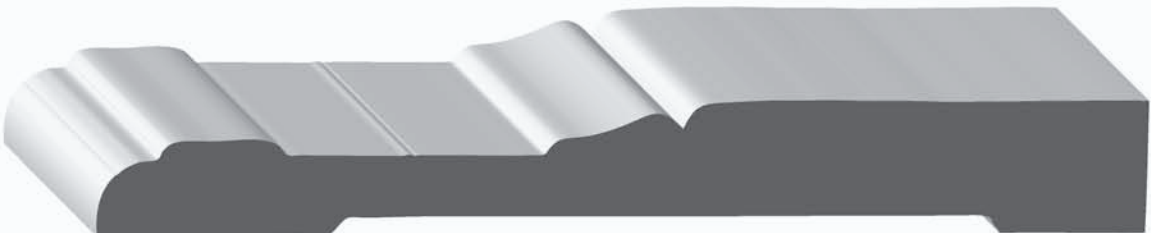

**1144**

**11/16" X 5-1/2"**



**1145**

**3/4" X 5-3/8"**

ALL RIGHTS RESERVED. MATERIAL SPECIFICATIONS MAY CHANGE WITHOUT NOTICE.

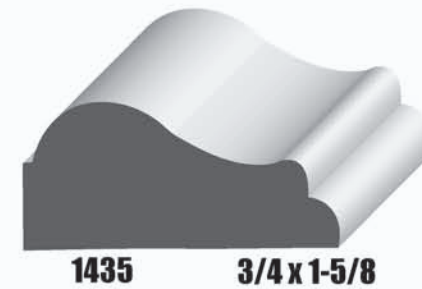
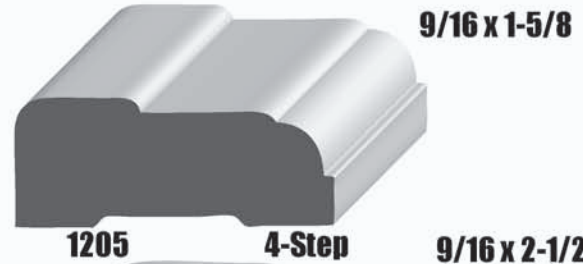
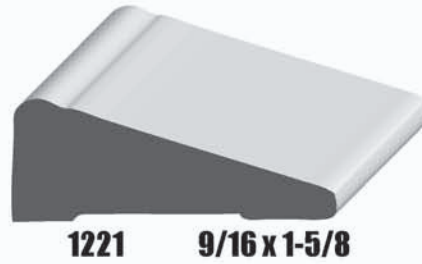
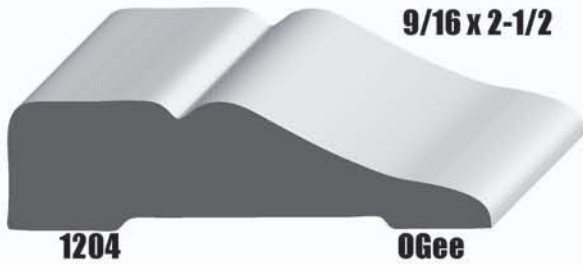
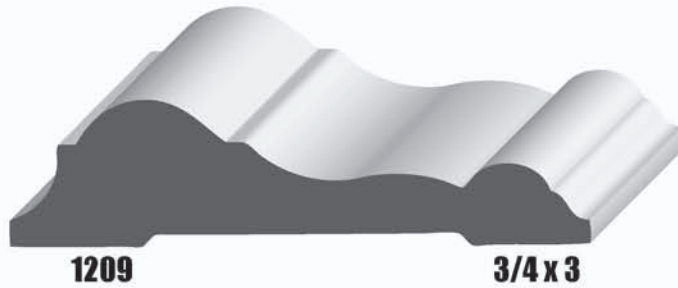
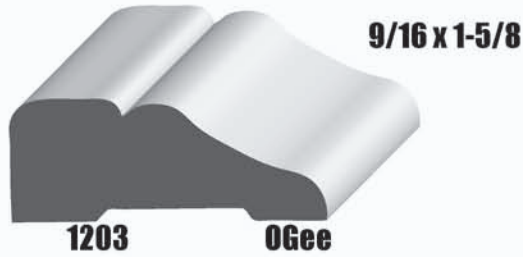
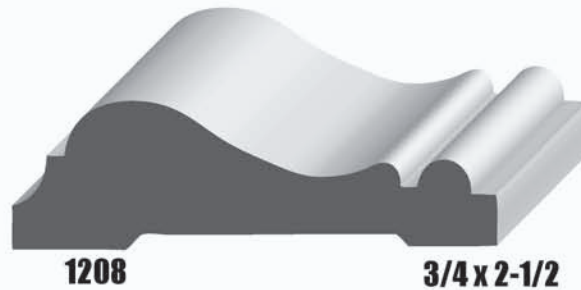
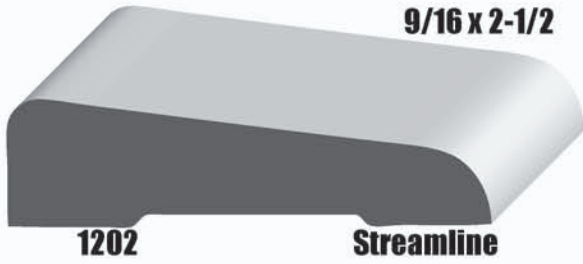
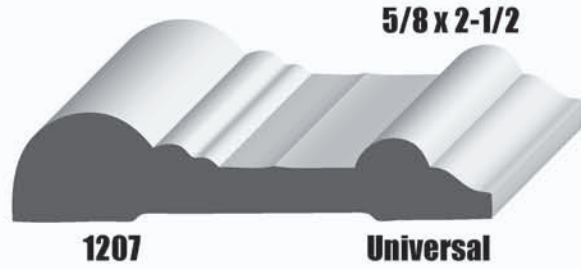
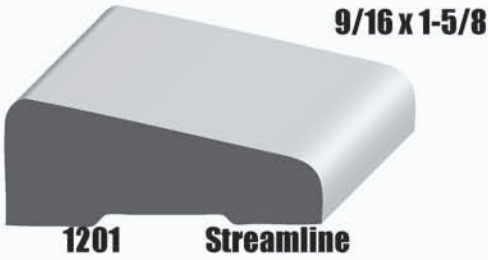

ALL RIGHTS RESERVED. MATERIAL SPECIFICATIONS MAY CHANGE WITHOUT NOTICE.

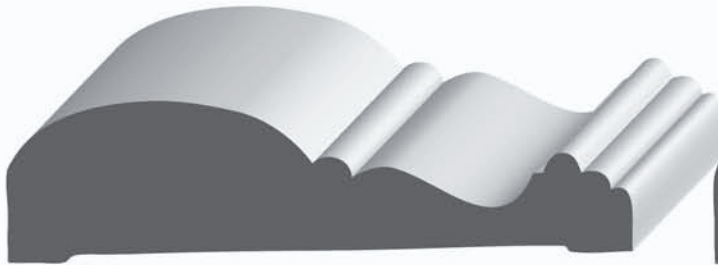

1210

25/32 x 3-1/4

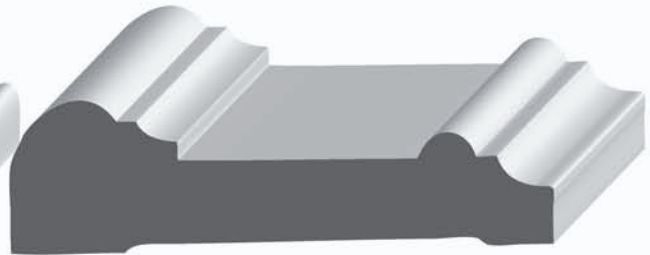

1211

13/16 x 2-7/8

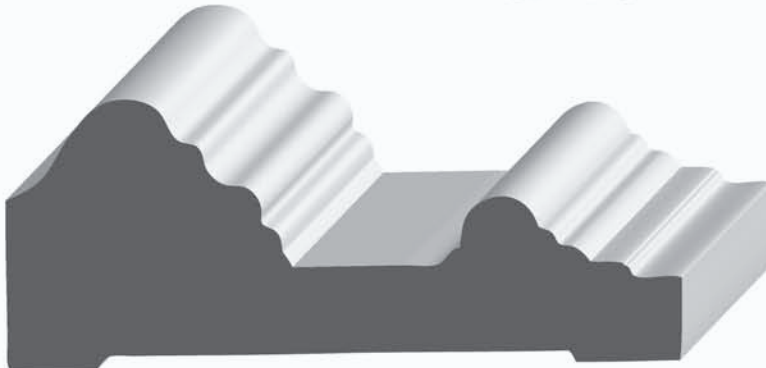

1212

1-3/8 x 3-1/2

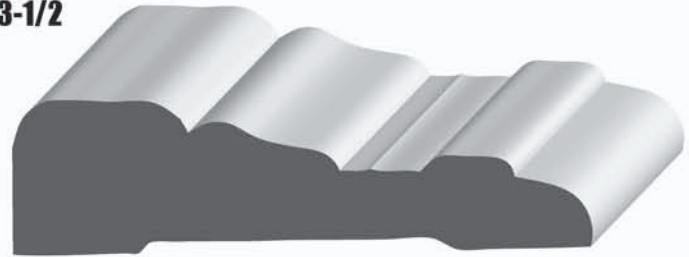

1213

13/16 x 3

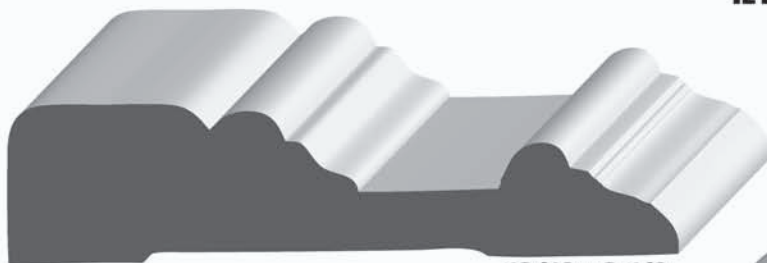

1215

13/16 x 3-1/2

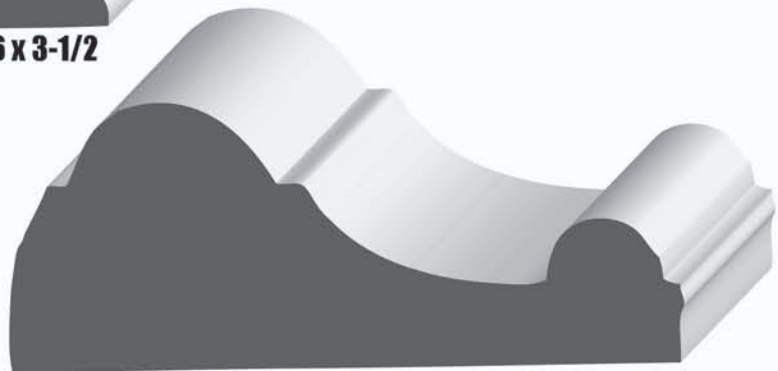

1216

1-3/8 x 3-1/2

ALL RIGHTS RESERVED. MATERIAL SPECIFICATIONS MAY CHANGE WITHOUT NOTICE.

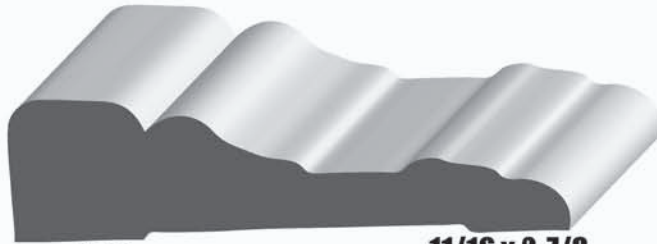

**1223**

**11/16 x 2-7/8**

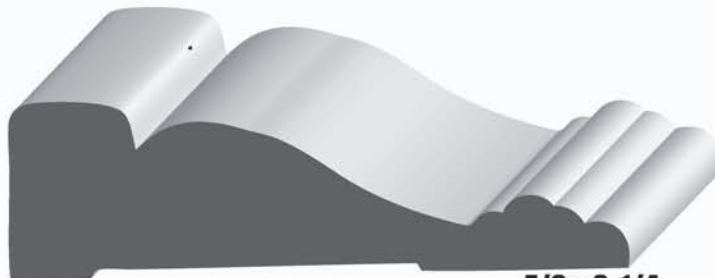

**1225**

**7/8 x 3-1/4**



**1226**

**3/4 x 3-1/2**



**1311**

**Fluting**

**1/2 x 3-1/2**



**1233**

**Chair Rail**

**3/4 x 4-1/2**

**11/16" X 7-1/4"**

**5/8" X 7-1/4"**



**1340**



**1345**

**5/8" X 5"**



**1330**

**11-16" X 5-1/4"**



**1315**

**11-16" X 3-1/4"**



**1314**

ALL RIGHTS RESERVED. MATERIAL SPECIFICATIONS MAY CHANGE WITHOUT NOTICE.



**1265**  
**5/8 x 2-1/4**

**Sprung-Cove**



**1264**  
**1-1/8 x 3-3/4**

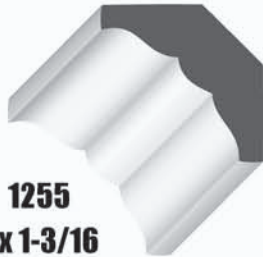

**1255**  
**11/16 x 1-3/16**



**1256**  
**7/8 x 2-1/2**

**Hoffco**



**1266**  
**9/16 x 2-1/2**

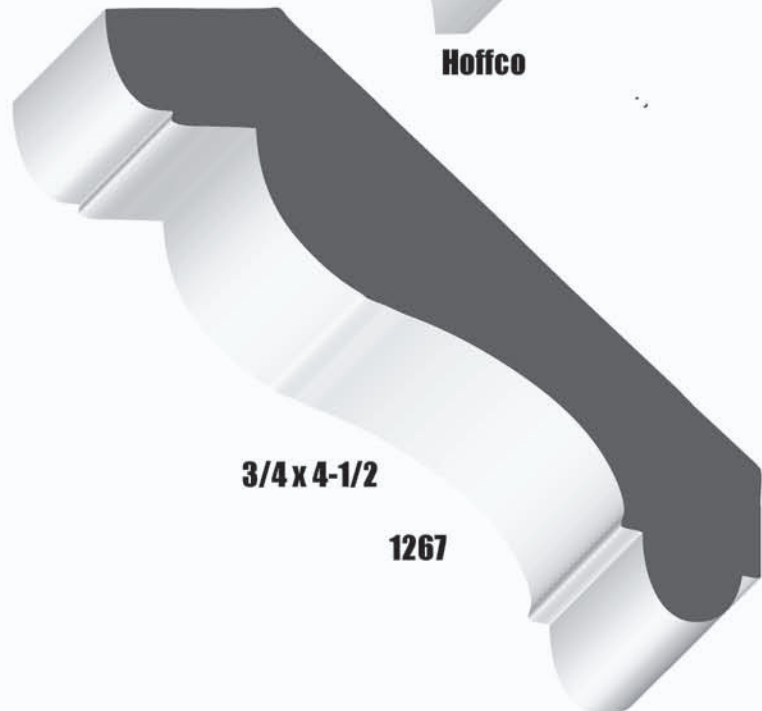

**3/4 x 4-1/2**

**1267**

ALL RIGHTS RESERVED. MATERIAL SPECIFICATIONS MAY CHANGE WITHOUT NOTICE.

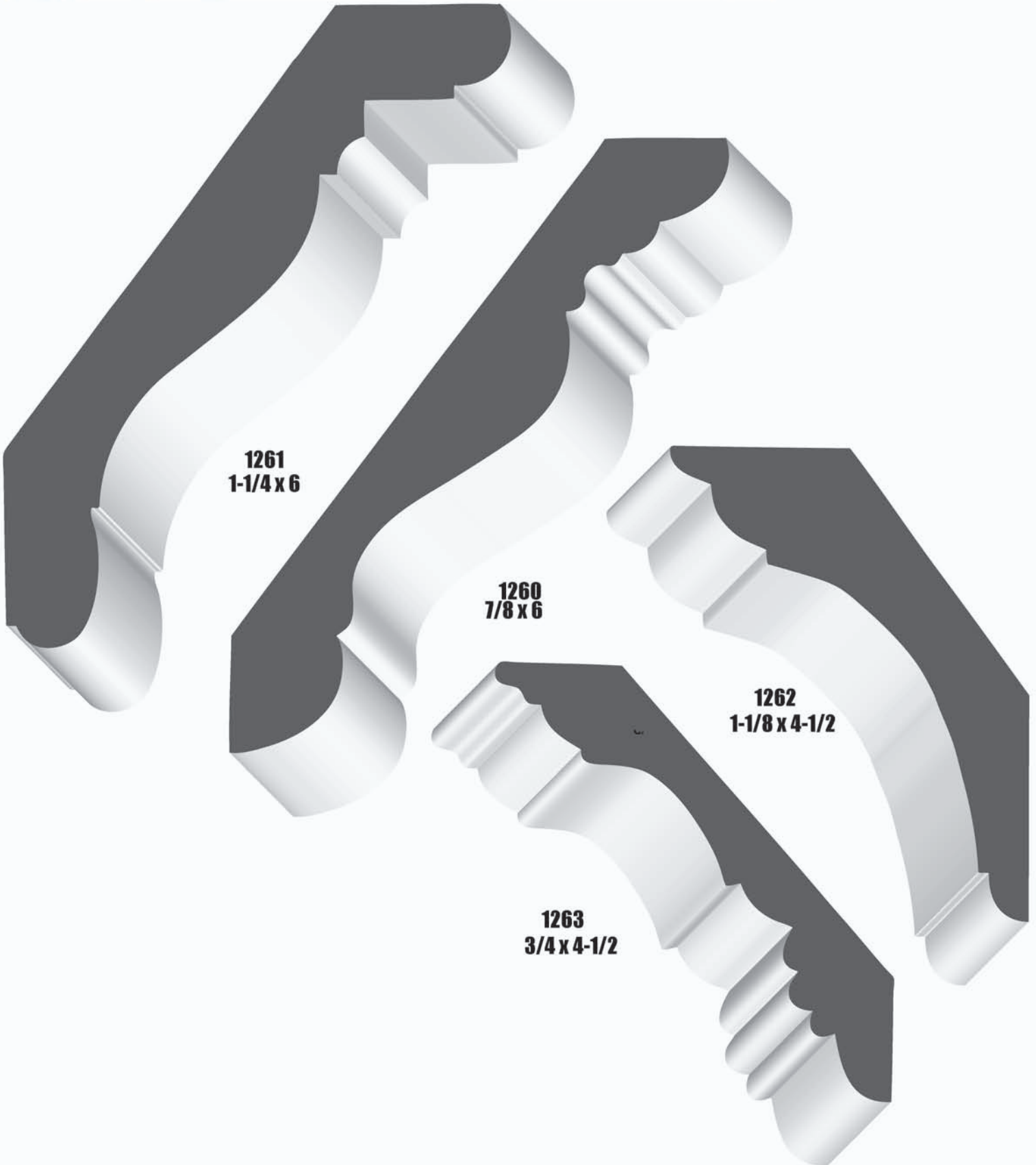

ALL RIGHTS RESERVED. MATERIAL SPECIFICATIONS MAY CHANGE WITHOUT NOTICE.

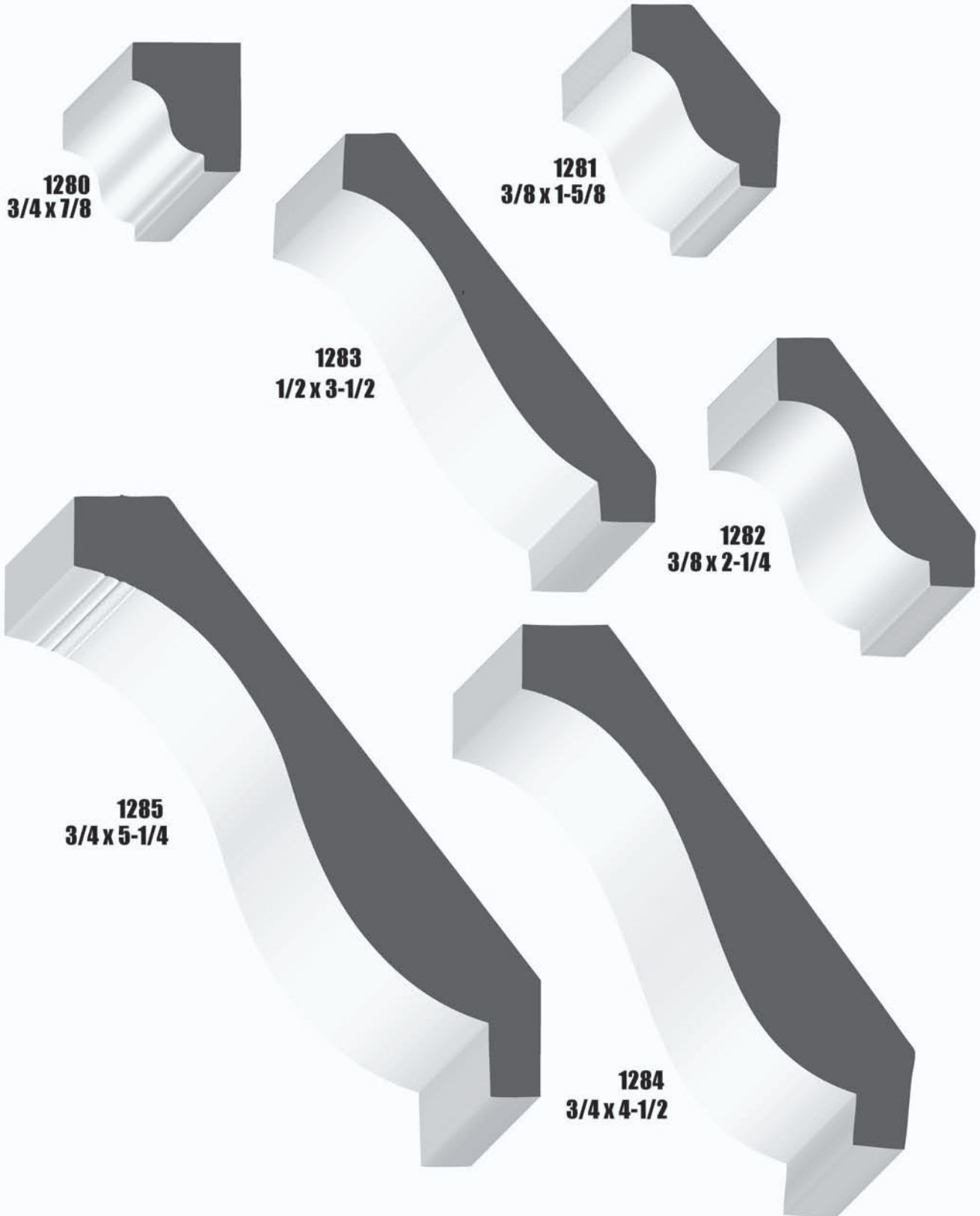

ALL RIGHTS RESERVED. MATERIAL SPECIFICATIONS MAY CHANGE WITHOUT NOTICE.

**1290**  
**7/8 x 7-1/4**

**1286**  
**3/8 x 2-1/4**

**1289**  
**3/4 x 5-1/4**

**1288**  
**3/4 x 4-1/2**

**1287**  
**1/2 x 3-1/2**

ALL RIGHTS RESERVED. MATERIAL SPECIFICATIONS MAY CHANGE WITHOUT NOTICE.

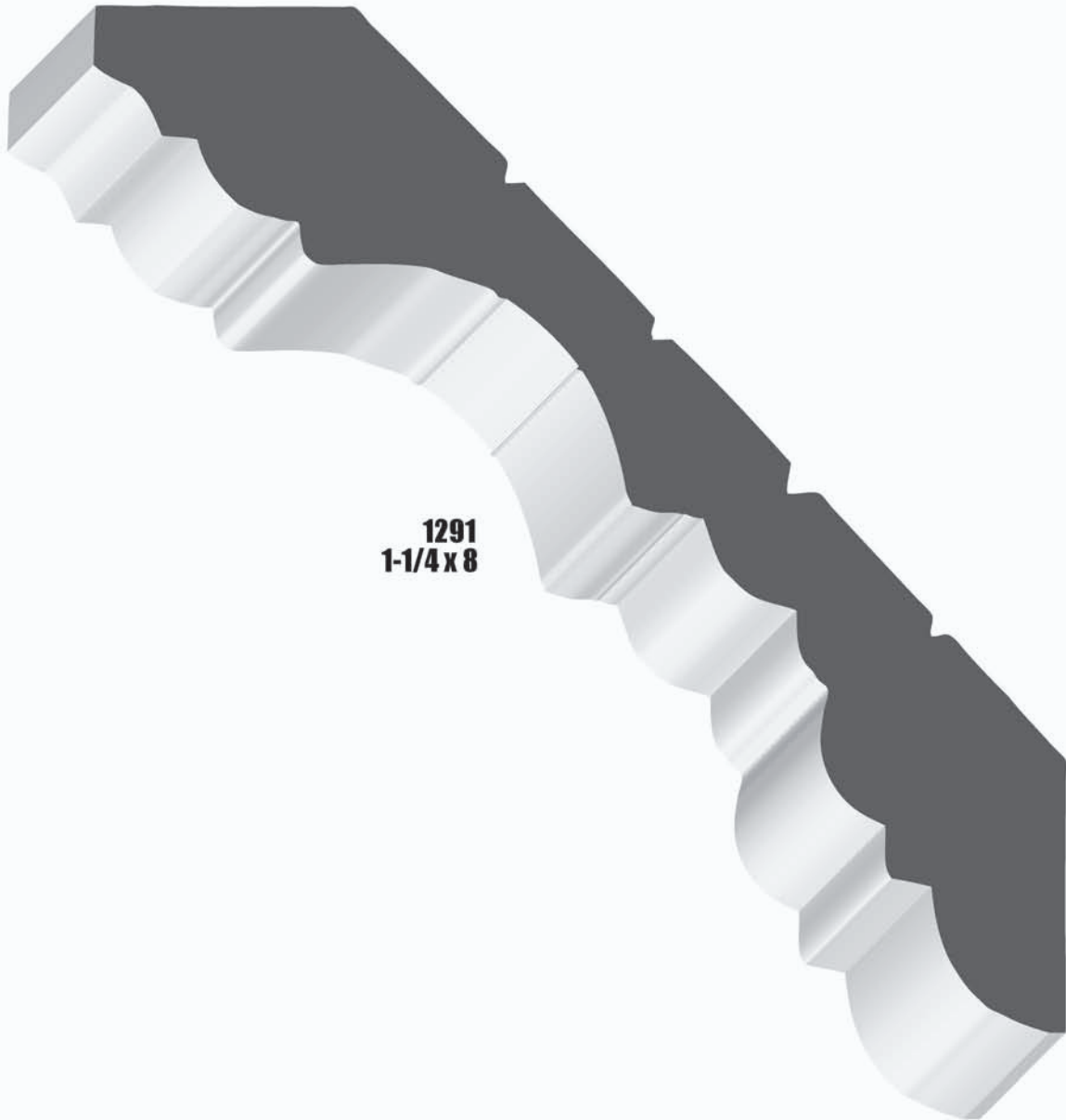

**1291**  
**1-1/4 x 8**

ALL RIGHTS RESERVED. MATERIAL SPECIFICATIONS MAY CHANGE WITHOUT NOTICE.

CASTLE MOULDING • 14959 DELANO ST. VAN NUYS, CA. 91411  
TEL 818.988.9663 FAX 818.988.4955 TOLL FREE 800.988.0000

# BAR RAIL

MOULDING

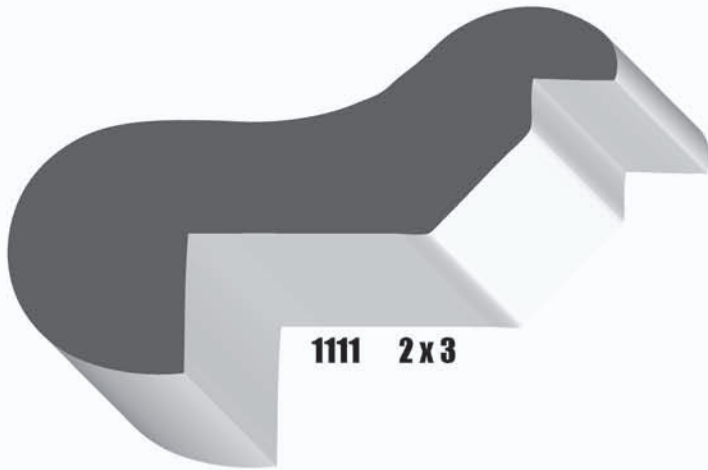

**1111 2x3**

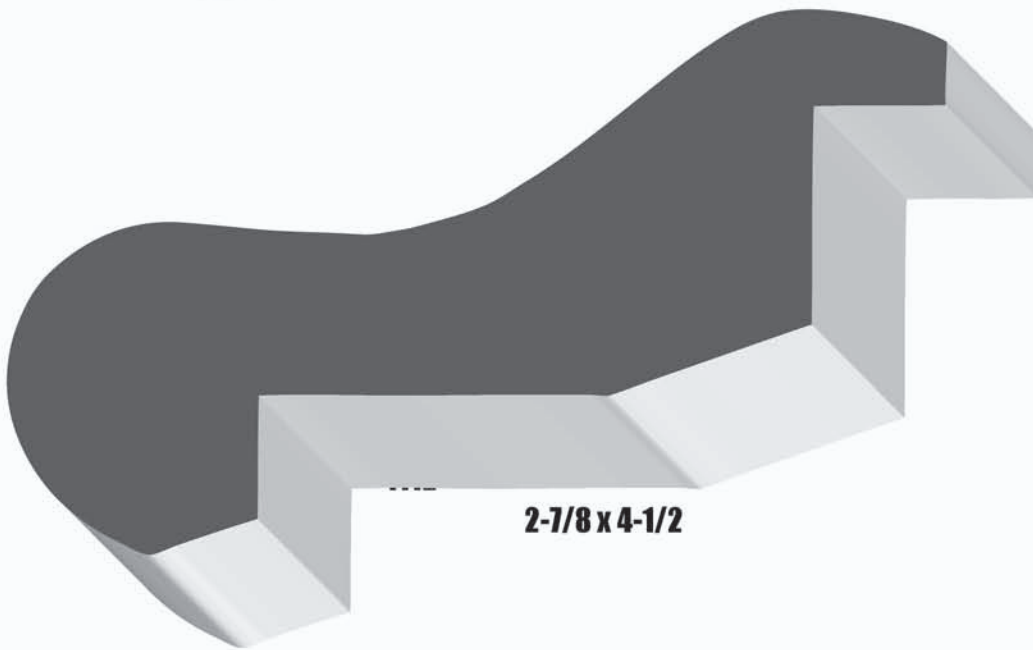

**2-7/8 x 4-1/2**

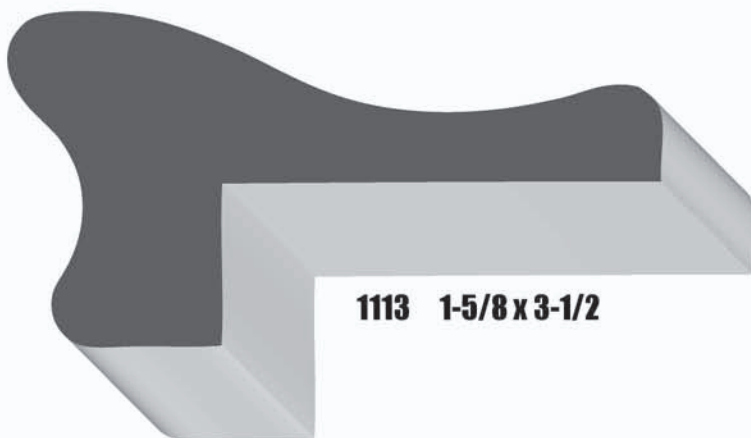

**1113 1-5/8 x 3-1/2**

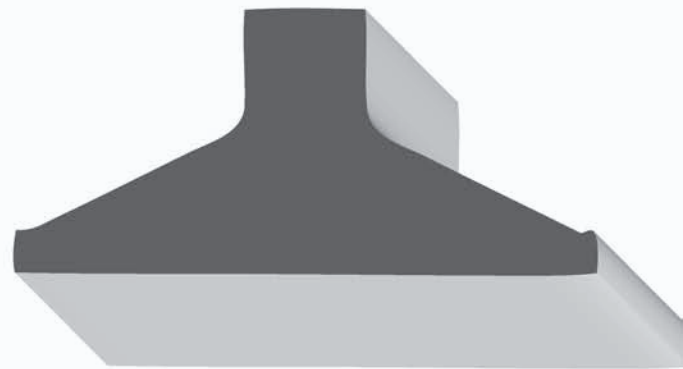

**1476**

**1-3/8 x 3**

**Stem Rail**

ALL RIGHTS RESERVED. MATERIAL SPECIFICATIONS MAY CHANGE WITHOUT NOTICE.

CASTLE MOULDING • 14959 DELANO ST. VAN NUYS, CA. 91411  
TEL 818.988.9663 FAX 818.988.4955 TOLL FREE 800.988.0000

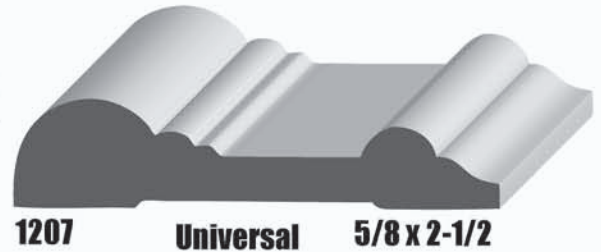
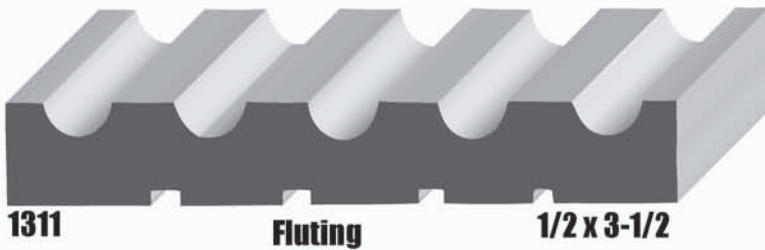
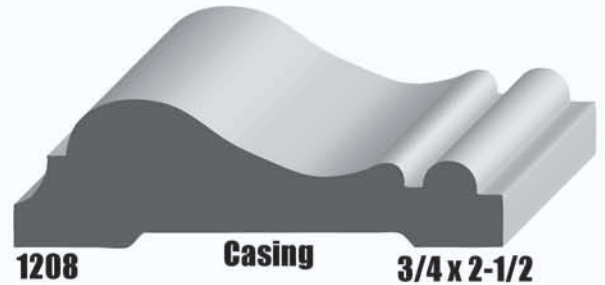
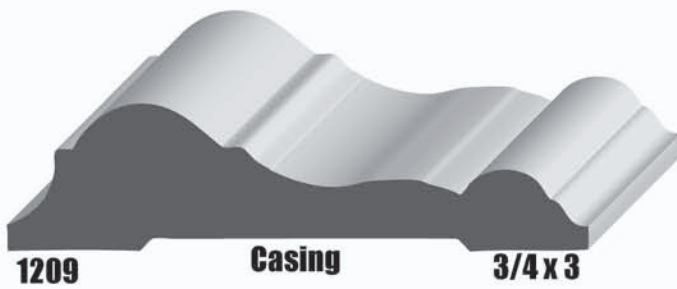
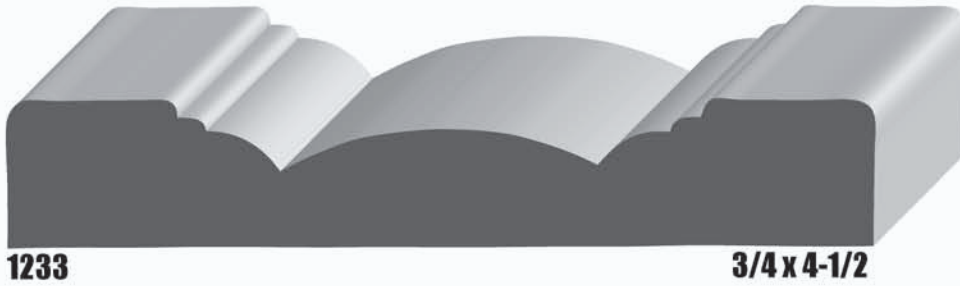
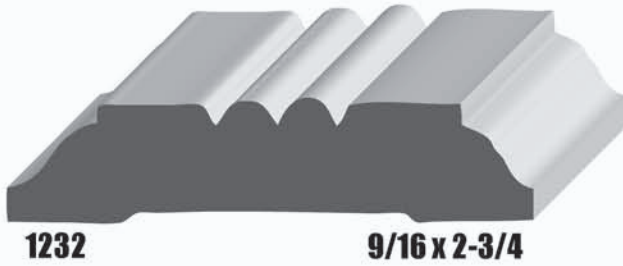
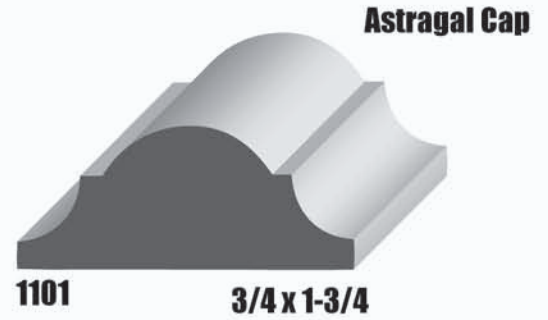
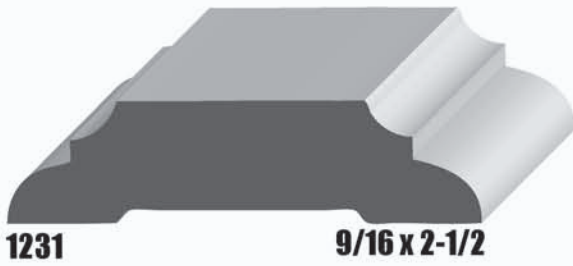

ALL RIGHTS RESERVED. MATERIAL SPECIFICATIONS MAY CHANGE WITHOUT NOTICE.

# COVE/OUTSIDE CORNER MOULDING



## Cove

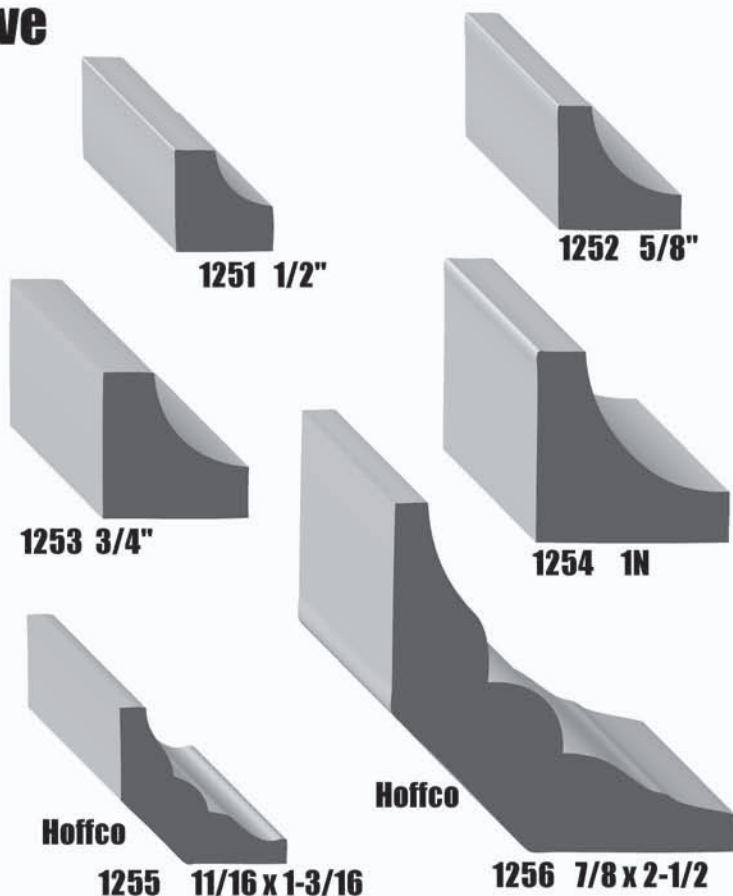

## Outside Corner

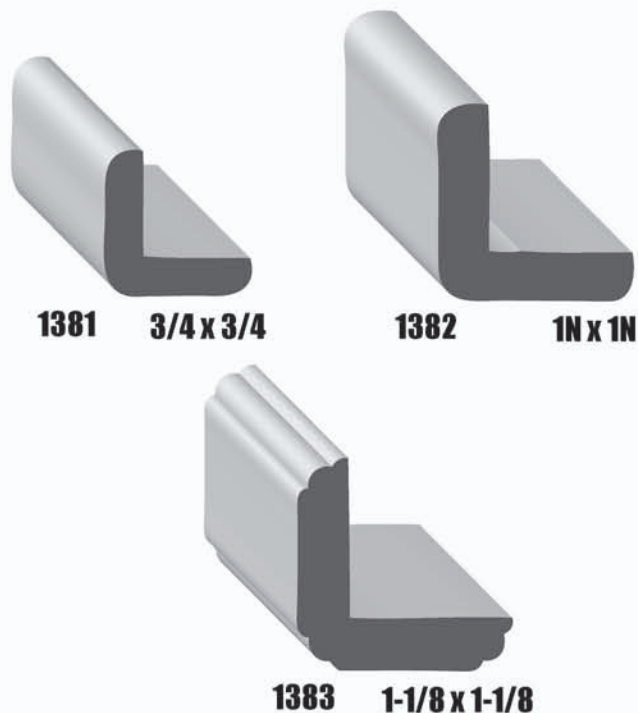

## Door Stop

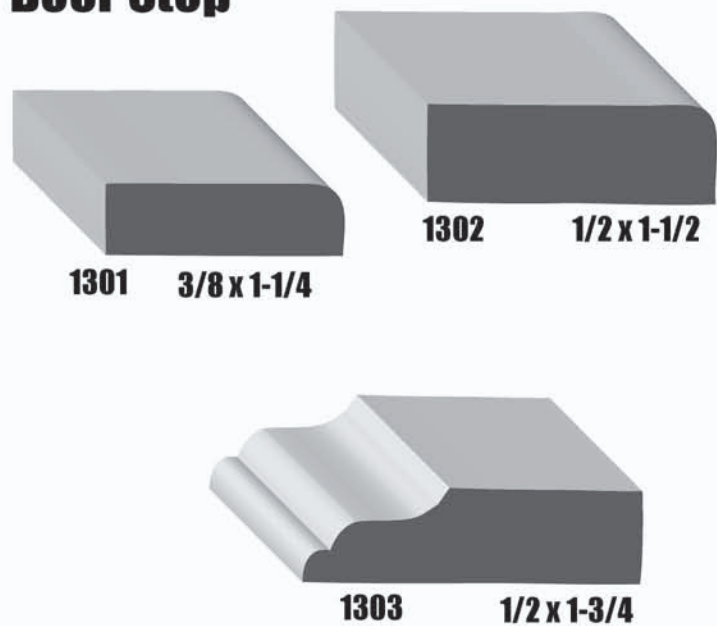

## T-Astragal

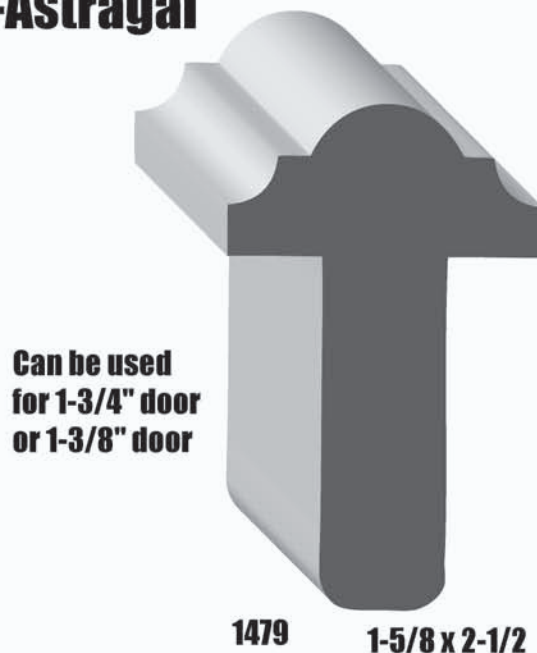

ALL RIGHTS RESERVED. MATERIAL SPECIFICATIONS MAY CHANGE WITHOUT NOTICE.

CASTLE MOULDING • 14959 DELANO ST. VAN NUYS, CA. 91411  
TEL 818.988.9663 FAX 818.988.4955 TOLL FREE 800.988.0000

# — HAND RAILS —

## MOULDING

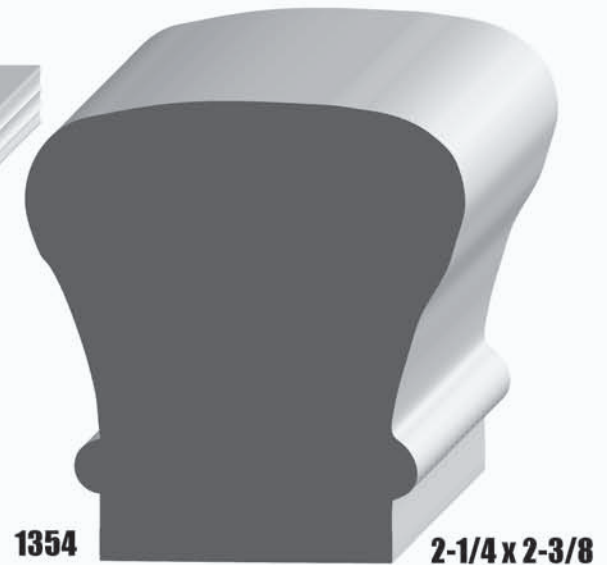
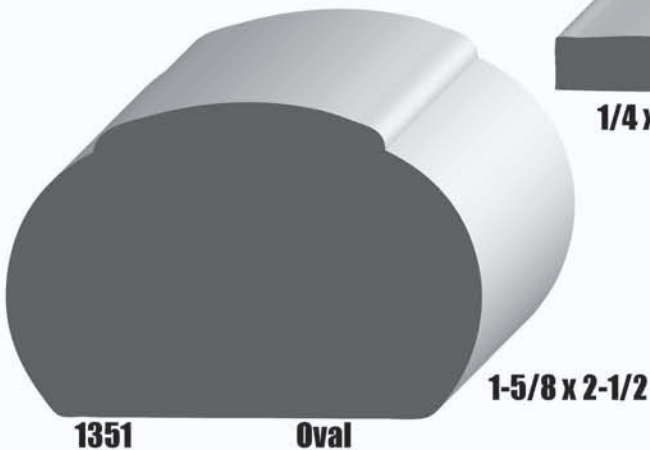
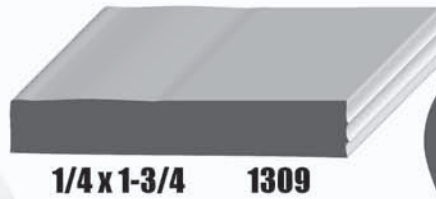
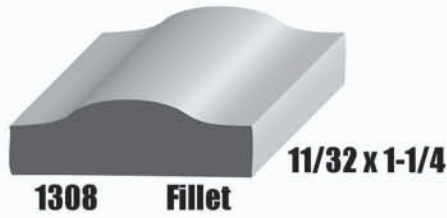
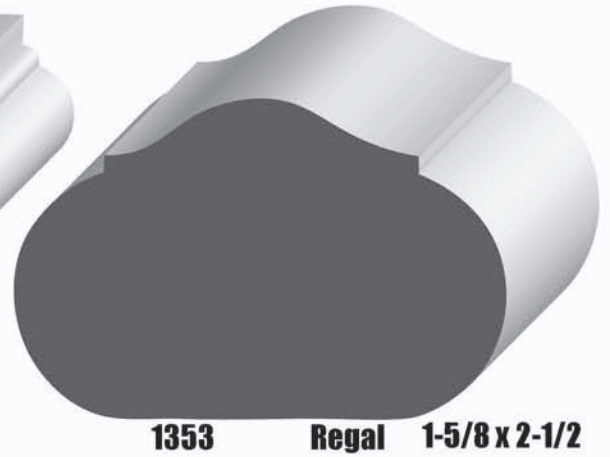
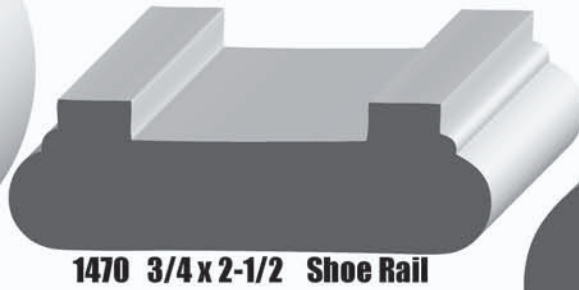
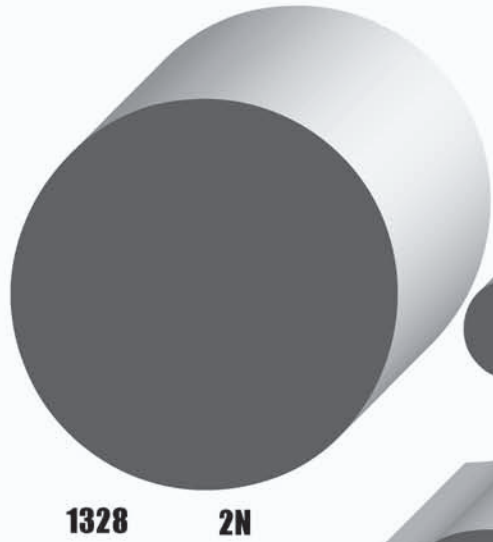
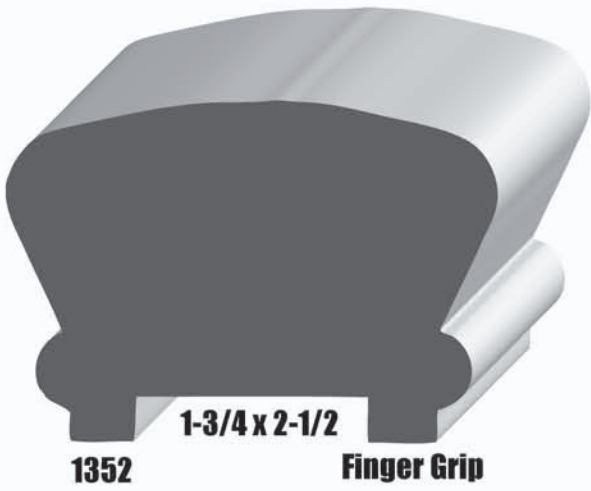

ALL RIGHTS RESERVED. MATERIAL SPECIFICATIONS MAY CHANGE WITHOUT NOTICE.

# MOULDING



## Full Round

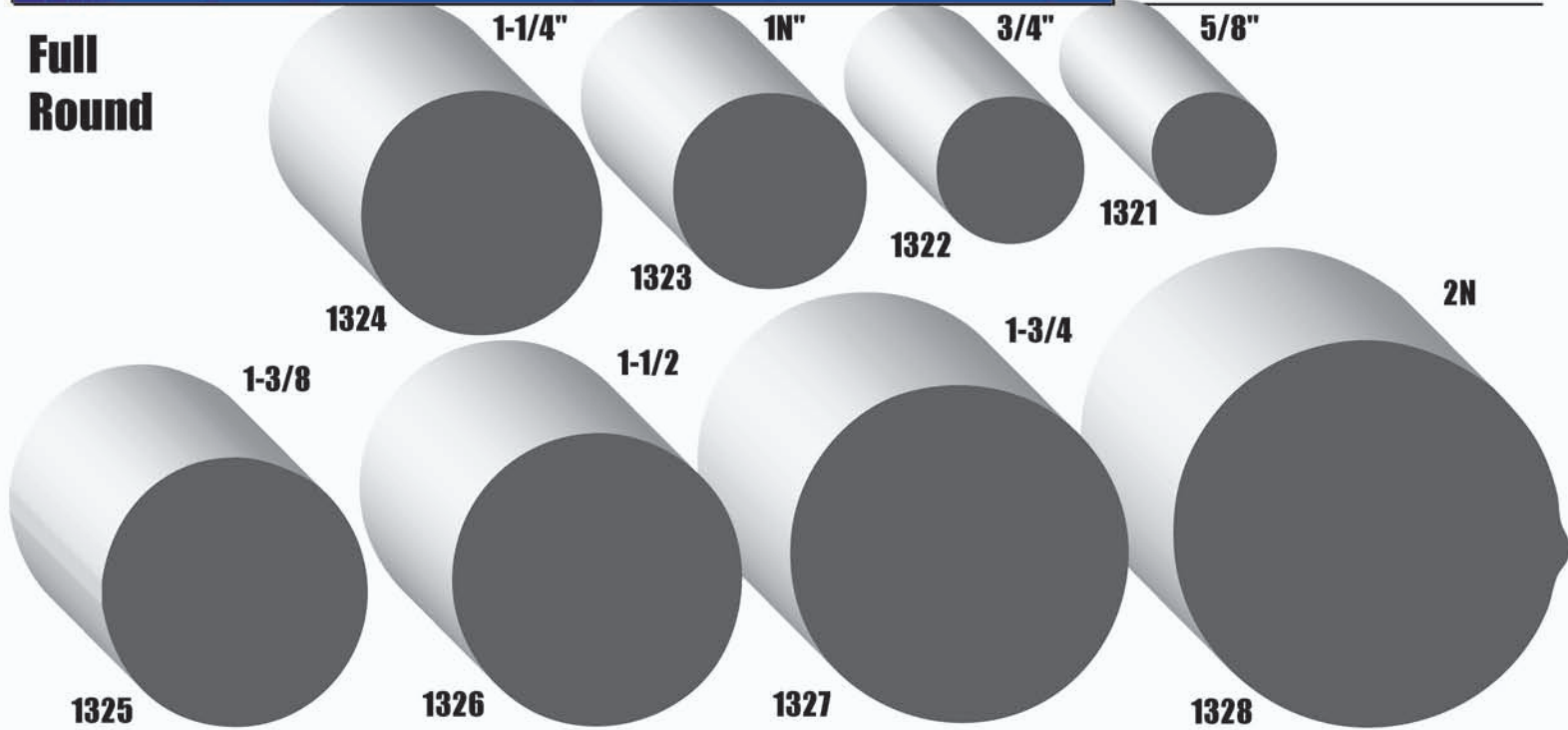

## Quarter Round

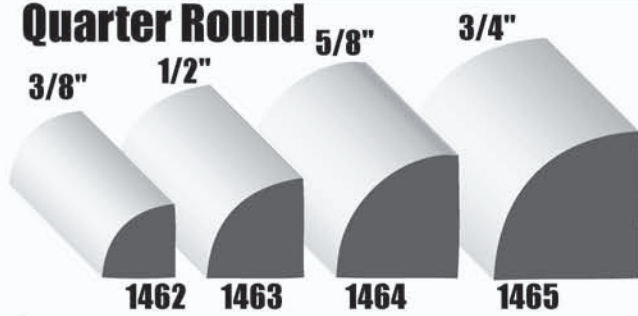

## Half Round

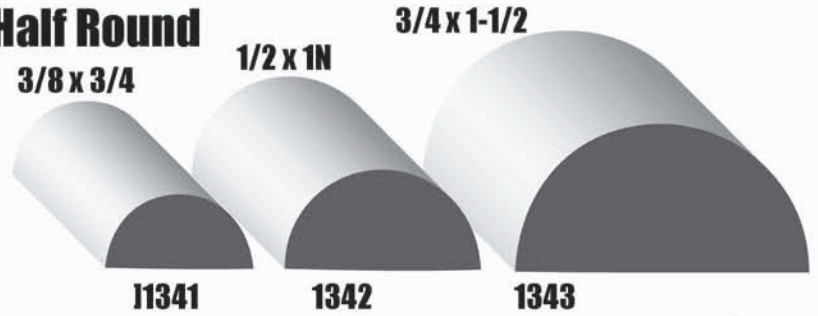

## Window Stool

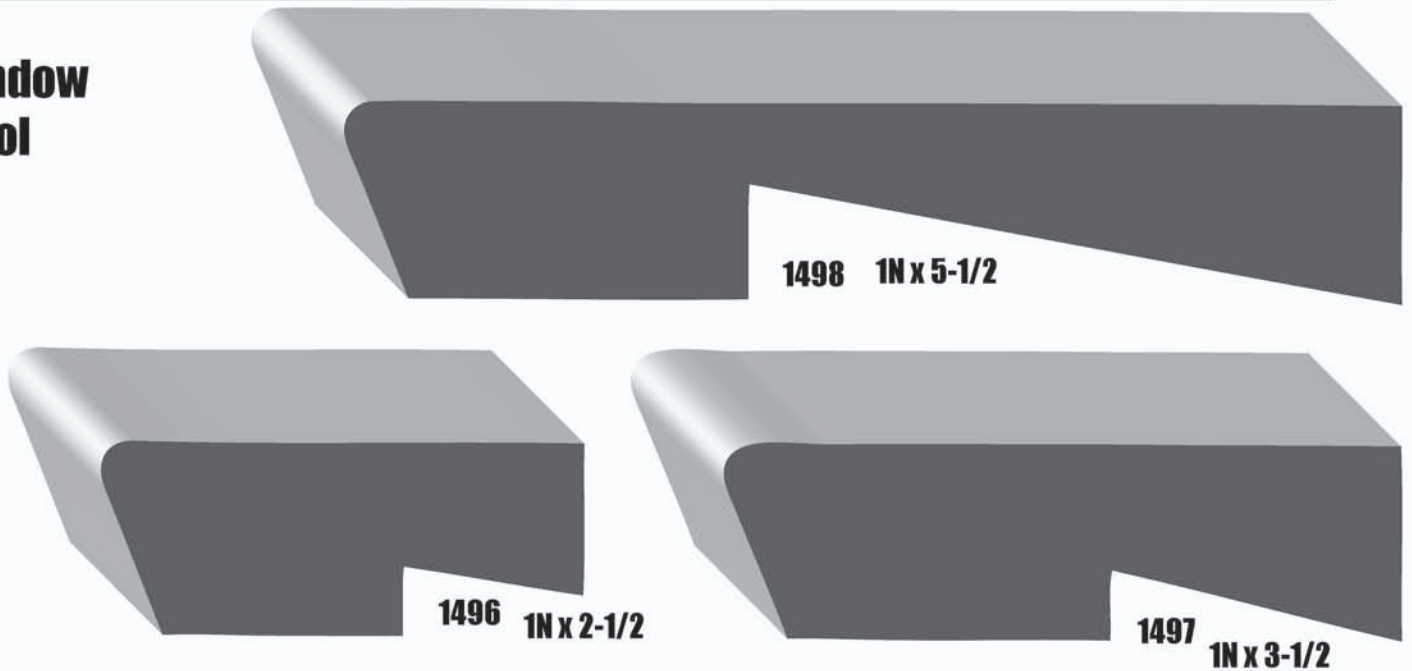

ALL RIGHTS RESERVED. MATERIAL SPECIFICATIONS MAY CHANGE WITHOUT NOTICE.

## Crested Plant On

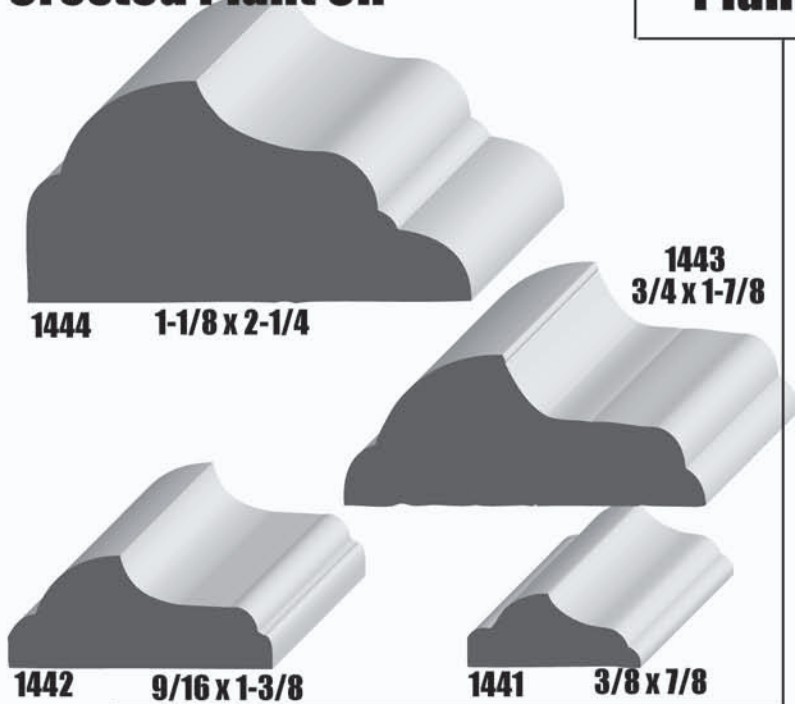

## Plant On

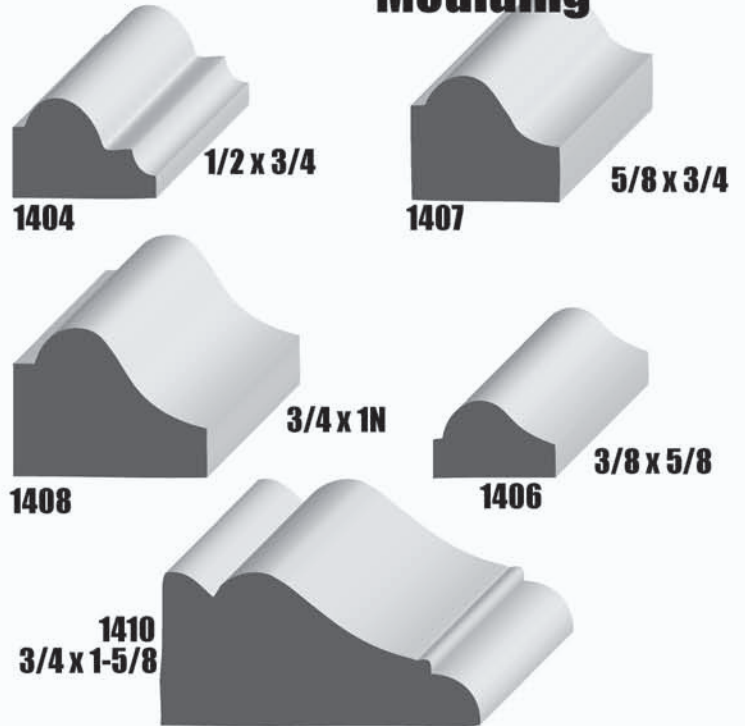

## Panel Moulding

## Plain Plant On



## Clover Leaf

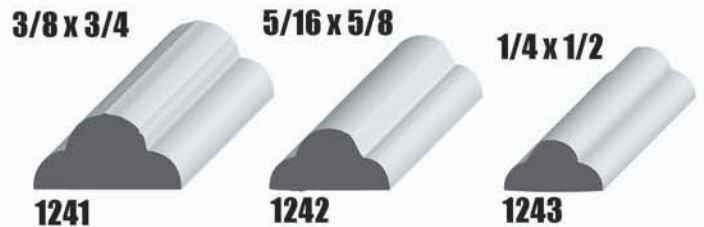

## Brick Moulding

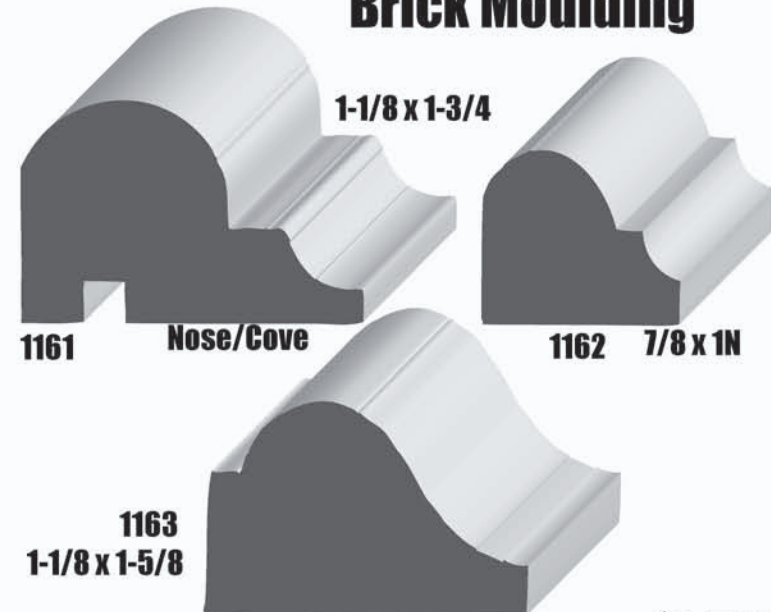

## Astragal Cap

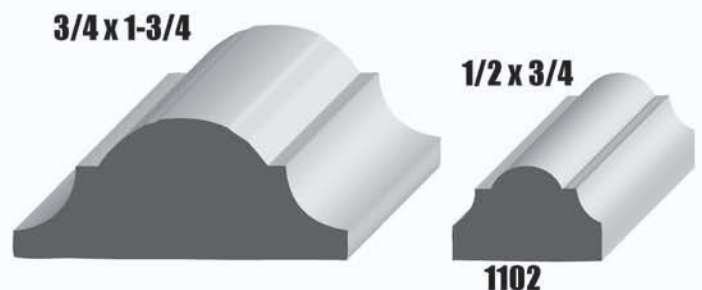

ALL RIGHTS RESERVED. MATERIAL SPECIFICATIONS MAY CHANGE WITHOUT NOTICE.

## Panel Moulding, Rabbeted

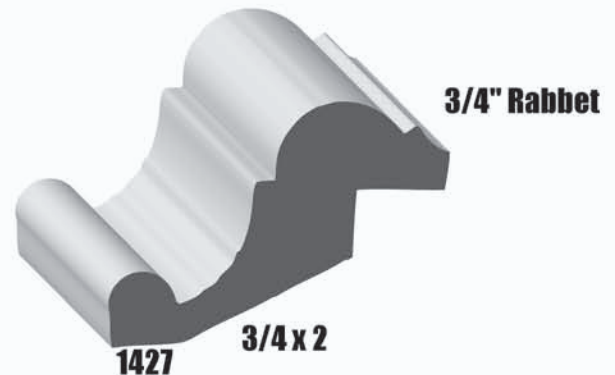
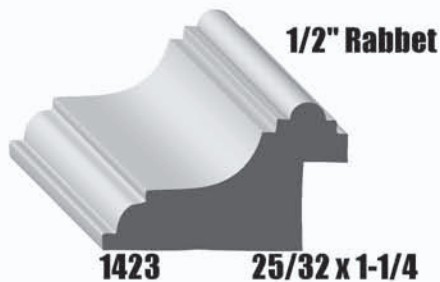
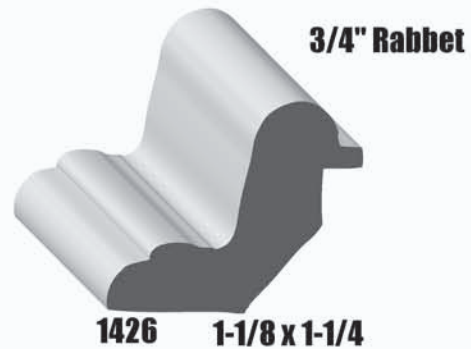
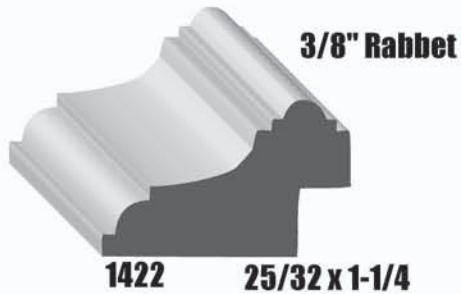
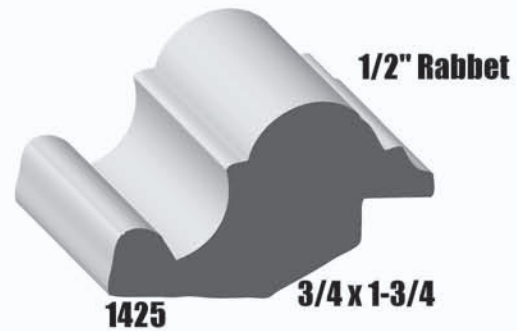
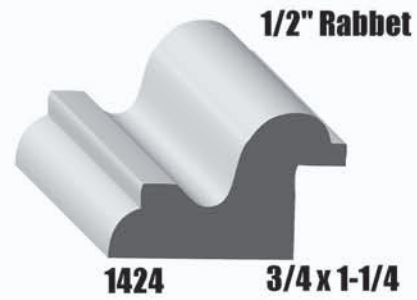
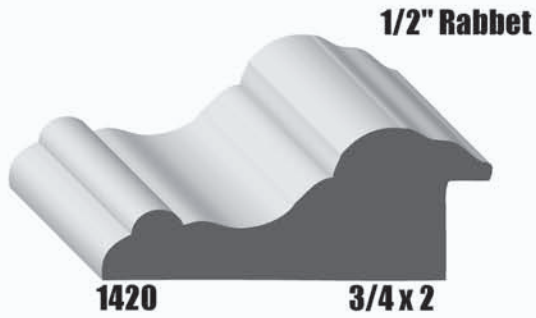

## Cap Moulding

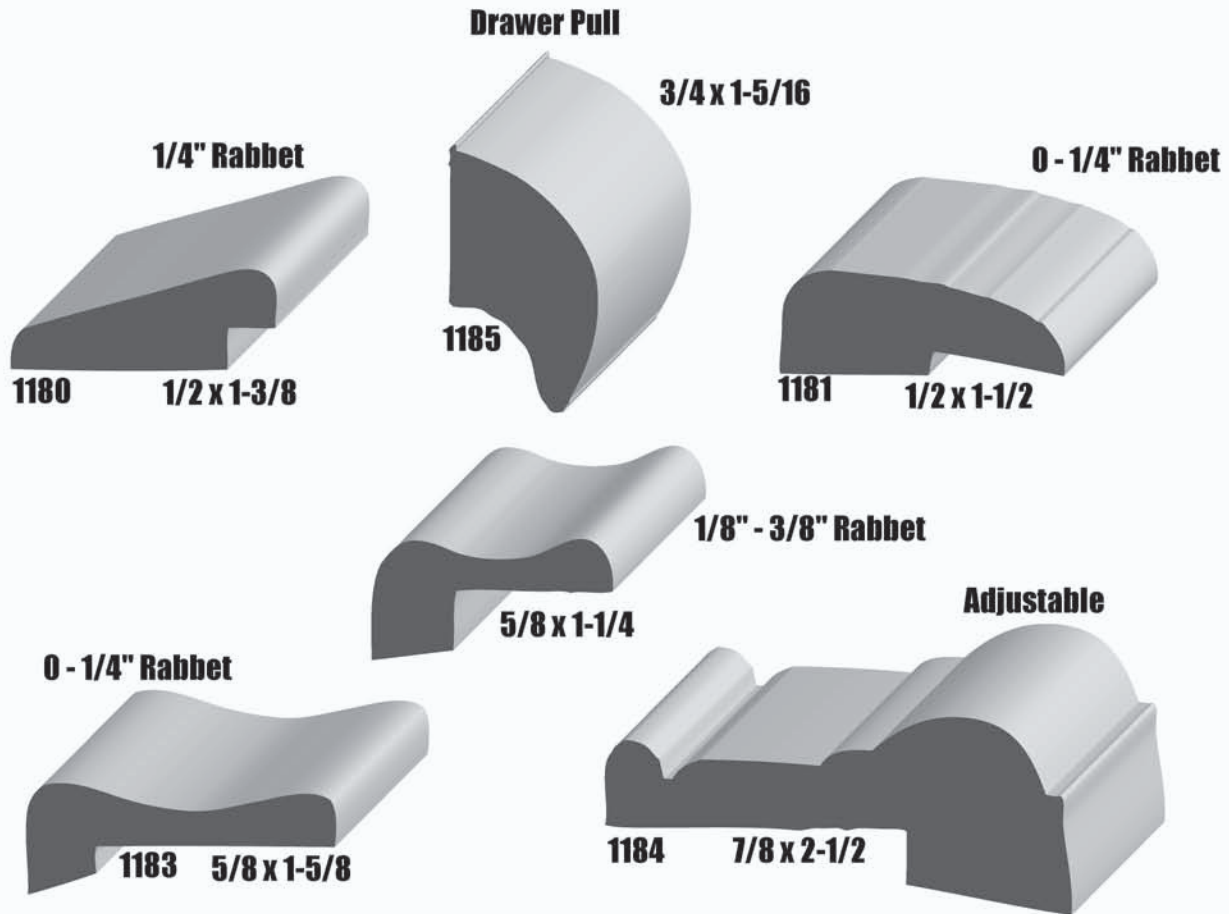

## Batten

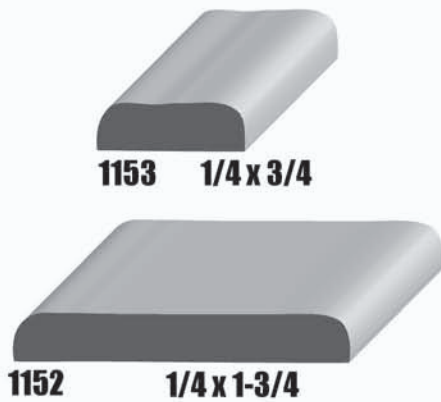

## Cabinet Moulding

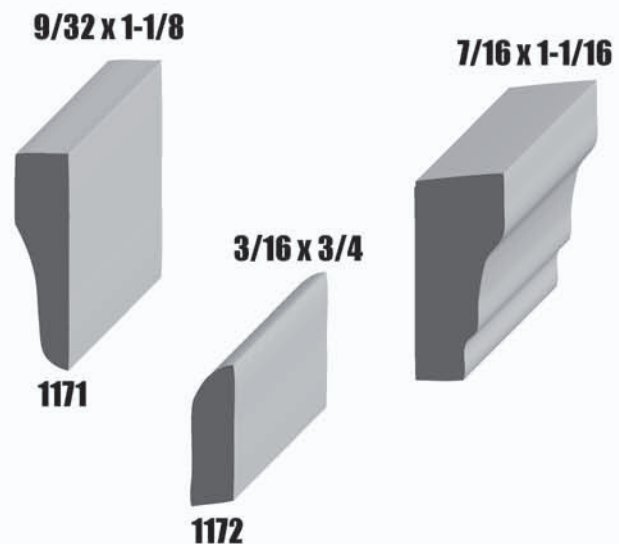

ALL RIGHTS RESERVED. MATERIAL SPECIFICATIONS MAY CHANGE WITHOUT NOTICE.

# DOOR JAMBS

## MOULDING



1-1/8 x 7-1/2



**1362**  
Exterior



**1360**

1-1/8 x 5-1/2

Exterior

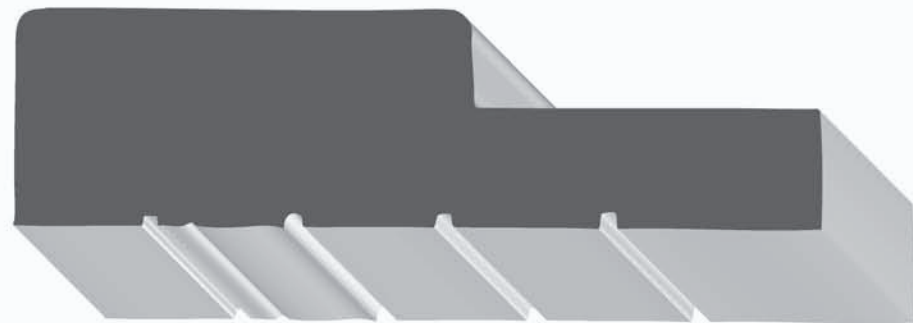

**1361**

1-1/8 x 4-1/8

Exterior



**1368**

3/4 x 4-9/16

Interior

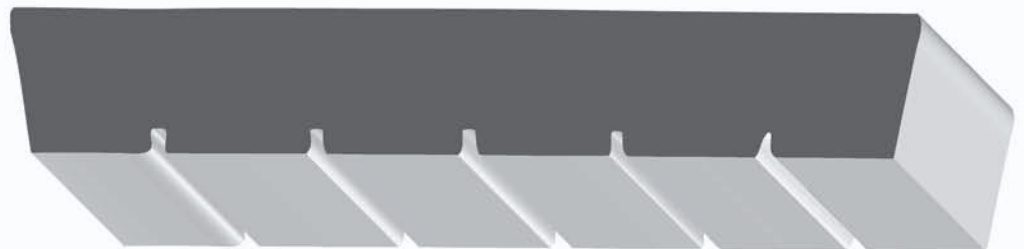

**1369**

3/4 x 4-13/16

Interior

ALL RIGHTS RESERVED. MATERIAL SPECIFICATIONS MAY CHANGE WITHOUT NOTICE.

CASTLE MOULDING • 14959 DELANO ST. VAN NUYS, CA. 91411  
TEL 818.988.9663 FAX 818.988.4955 TOLL FREE 800.988.0000

***Quality • Beauty • Craftsmanship • Style***

Solid Wood Is The Ultimate in Elegance

Enhance The Beauty Of Any Project

Hardwood Will Provide A Lifetime Of Beauty



TEL 818.988.9663 FAX 818.988.4955  
TOLL FREE 800.848.5556

***Castle Moulding • 14959 Delano St. Van Nuys, CA. 91411***